



Product Overview

Solutions for your single-use and multi-use biopharma processes

Steriflow Valve is a Division of Richards Industries

Steriflow Valve revolutionized the industry in the late 1980s with the introduction of the Mark 96 and 95 sanitary pressure regulators. The bio-pharmaceutical industry created a demand for advanced valve solutions capable of ensuring precise pressure control for validated steam and purified water applications. Jordan Valve's Steriflow "regulator" emerged as the market

leader, offering a dependable pressure reducing valve and back pressure regulator that adhered to the industry's rigorous standards for drainability, particulate minimization, surface finish and minimal offset. For precise control of clean steam pressure control, buffer pressure control and purified water back pressure control, contact Steriflow Valve.

Industry leader for sanitary regulators & control valves for over thirty years

By 2007, Steriflow Valve had successfully introduced several control valves, regulators and clean steam specialty products. The Steriflow Valve division was created to nurture continued innovation and to broaden its product scope.

Today, Steriflow Valve has a complete line of pressure regulators, control valves, gas pressure regulators, check valves, sanitary safety relief valves, diaphragm valves, steam traps, ball valves and SIP accessories.

Steriflow has introduced a broad range of industry firsts for the bio-pharmaceutical industry:

- » The industry's first and only Lifetime Diaphragm Warranty
- » The first true spring-less and crevice-free check valve for horizontal and vertical line WFI and bioprocess applications
- » The world's only down-flow check valve for bioprocess drain applications
- » The world's first precision aseptic metering valve
- » The world's largest pure steam trap and accessory product range including: products that shorten SIP heat-up time and eliminate validation temperature alarm and reduce dripleg length
- » The first clean gas regulator product line developed specifically for bio-pharmaceutical applications
- » The first clean gas regulators designed specifically for reliable control of low flows and low pressures
- » The first U.S. manufactured AMSE sanitary safety relief valves
- » Sanitary steam traps with subcooling temperatures as low as 3°F (1,7°C) or less

Certifications, Credentials & Affiliations

Credentials

All Material Test Reports comply with the requirements of BSEN 10204, Type 3.1

Plastic and elastomer Certifications of Compliance included with every order:

- » FDR CFR Title 21, Paragraph 177.1550 for plastic materials FDA
- » FDR CFR Title 21, Paragraph 177.2600 for elastomer materials
- » U.S. Pharmacopeia XXVIII Class VI, Chapter 88 Biological Reactivity Test in Vivo
- » U.S. Pharmacopeia XXVIII, Chapter 87 Biological Reactivity Test in Vitro
- » ADI/TSE Free Certificate
- » Batch lot traceability for elastomer and plastic components

Steam trap fill fluids meet FDA/ICH Q3C/FDA Class 3 criteria designation

Documentation & Traceability

All Steriflow valves have serial numbers that are directly traceable to our Unicert, and to the heat numbers on the type 3.1 material test reports attached.

Affiliations

- » ASME
 - » ASME BPE (membership & committee member)
 - » ISPE
 - » FCI (membership and Vice President)
 - » P.E. Registered Professional Engineer - State of Ohio, USA
 - » Valve Manufacturers Association (VMA)
-

Credentials

- » ISO 9001:2015
- » Pressure Equipment Directive 2014/68/EU/PED Category 1
- » CE (Conformité Européene)
- » ATEX (Atmosphère Explosible) Certification available on designated products
- » Canadian Registration Numbers (CRN) available on all products



The Jorlon™ Diaphragm: Unparalleled Reliability

What Is Jorlon™?

Jorlon™ is structurally modified pure PTFE. It is manufactured by a proprietary technique where PTFE layers are combined and formed in a unique process to reduce the creep and cold flow associated with conventionally formed solid or laminated PTFE or Teflon.

Jorlon™ is featured in all of Steriflow's valve product lines:

- » Mark 978 Control Valves
- » JSHM Manual Metering Valves
- » Mark 96 Pressure Regulating Valves
- » Mark 95 Back Pressure Regulating valves
- » Mark 96A, 96AA, 95A, 95AA Air Loaded Regulators
- » J Series Clean Gas Pressure & Back Pressure Regulators

Physical Properties of Jorlon™

Color		Clear, translucent
Composition		PTFE
Temperature	Maximum	500° F/260°C
Creep Relaxation (ASTM F38)	%	35
Specific Gravity (D792)		2.19
Compressibility (ASTM F36)	% Range	20 - 25
Recovery (ASTM F36)	Minimum %	50
Tensile Strength (ASTM D1708)		
X Direction	psi (N/mm ²)	5000 (35)
Y Direction	psi (N/mm ²)	5100 (36)
Ultimate Elongation (ASTM D1708)		
X Direction	%	500
Y Direction	%	520
Gas Permeability (ASTM D1434V)	CC/M2/24 hrs	10,000
Flammability		Will not burn
Industry Approvals/Certifications		FDA CFR 21 177.1550, USP <88> Class VI USP <87> ADI Free



Lab tests comparing Jorlon™ to 316L diaphragms have shown continued life after exceeding the SST failure cycle count by more than 100 times.

Steriflow Valves in Bioreactor Processing

Unmatched Expertise & Product Range

Process engineers and researchers depend on Steriflow Valve for our comprehensive range of sanitary products, designed to meet the diverse fluid control needs in biopharma processing. Our products offer precise flow and pressure control, suitable for both upstream and downstream bioprocessing applications, including usage with Water for Injection (WFI), clean process gases, steam, and for Clean-in-Place (CIP)/Steam-in-Place (SIP) processes. Our experienced engineers collaborate with you to identify the most effective fluid control solutions for your specific applications. Discover the versatility of our valves in various stages of the bioreactor process.

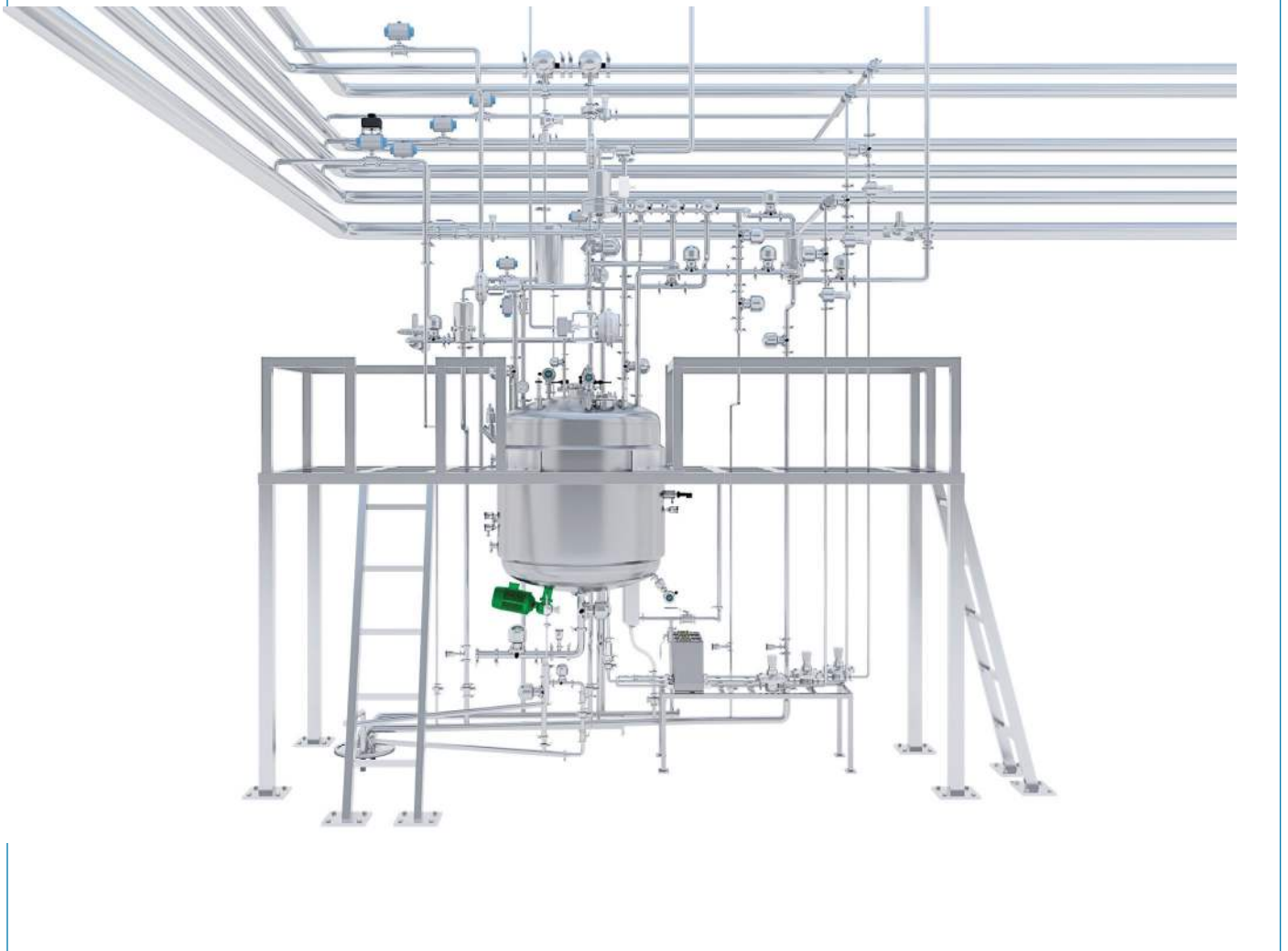

Sanitary Control Valves Low, Medium, High Flows



Angle style or inline control valves, for continuous precision control of media, process, purified water and clean utilities in the biopharmaceutical, pharmaceutical, food & beverage and consumer health & beauty industries:

- » Bioreactor/fermenter process input control: growth media, buffer, WFI, sparge and blanket gas
- » Separation input and output control: WFI, process, product & waste streams
- » Small vessel formulation / fill control: WFI and other vessel inputs, blanket gas, dosing pressure
- » 3A certification for Food & Beverage line
- » Purification input and output control: elution media, solvents, buffer, WFI
- » Formulation / fill control: WFI and other vessel inputs, blanket gas, dosing pressure
- » Clean utilities: WFI, pure steam, CIP, clean compressed air and gas

MARK 978 SERIES, MEDIUM TO HIGH FLOW, CONTROL VALVE

Sizes	Angle & Inline body: 1/2" - 3" (DN15 - DN80) - Jorlon Diaphragm 1/2" - 2" (DN15 - DN50) - O-Ring Stem Seal
End Connections	ASME, DIN & ISO Tri-Clamp, Extended Tube Weld
Cv (Kv) & Flow Characteristic	0.2 - 125 Cv (0,17 - 108 Kv), Linear, Equal Percentage or Quick Opening - Jorlon Diaphragm 0.2 - 60 Cv (0,17 - 51,6 Kv), Linear, Equal Percentage or Quick Opening - O-Ring Stem Seal
Max Pressure/Temperature	150 psi (10,3 bar) at 100°F (38°C); 100 psi (6,9 bar) at 340°F (171°C) - Jorlon Diaphragm 450 psi (31 bar) at 100°F (38°C); 450 psi (31 bar) at 450°F (232°C) - O-Ring Stem Seal dependent upon body construction and o-ring
Wetted Material & Surface Finish	ASTM SA479 316L or 1.4435 SST; ASME BPE SF5, 20 Ra (0,5 µm) electropolish is standard, 8 Ra (0,2µm) optional
Stem Seal - Diaphragm	All materials certified to FDA/USP Class VI - Jorlon Various, all certified to FDA/USP Class VI - O-Ring
Soft Seat Option (Cv ≥ 3.5 only)	PTFE FDA/USP Class VI; PEEK FDA/USP Class VI

MARK 978LF SERIES, LOW FLOW, CONTROL VALVE

Sizes	1/2" & 3/4" (DN15 & 20)
End Connections	ASME, DIN & ISO Tri-Clamp, Extended Tube Weld
Cv (Kv) & Flow Characteristic	0.005 - 0.1 Cv (0,0043 - 0,086 Kv), Linear or Equal Percentage
Max Pressure/Temperature	200 psi (13,8 bar) - Jorlon diaphragm dependent upon body construction; O-Ring dependent upon construction
Wetted Material & Surface Finish	ASTM SA479 316L or 1.4435 SST; ASME BPE SF5, 20 Ra (0,5 µm) electropolish is standard, 8 Ra (0,2µm) optional
Stem Seal - Diaphragm	All materials certified to FDA/USP Class VI - Jorlon Various, all certified to FDA/USP Class VI - O-Ring

MARK 978M SERIES, LOW TO HIGH FLOW, MANUAL CONTROL VALVE

Sizes	Angle & Inline body: 1/2" - 2" (DN15 - DN50)
End Connections	ASME, DIN & ISO Tri-Clamp, Extended Tube Weld
Cv (Kv) & Flow Characteristic	0.2 - 70,1 Cv (0,17 - 60,5* Kv), Linear, Equal Percentage or Quick Opening (*modified linear)
Max Pressure/Temperature	150 psi (10,3 bar) at 100° temperature dependent on o-ring construction
Wetted Material & Surface Finish	ASTM SA479 316L or 1.4435 SST; ASME BPE SF5, 20 Ra (0,5 µm) electropolish is standard, 8 Ra (0,2µm) optional
Stem Seal - O-ring	All materials certified to FDA/USP Class VI - Jorlon
Soft Seat Option (Cv ≥ 3.5 only)	PTFE FDA/USP Class VI; PEEK FDA/USP Class VI

FBCV-OR SERIES, 3A APPROVED, O-RING STYLE STEM SEAL, PROCESS CONTROL VALVE

Sizes	1/2" - 4" (DN15 - DN100)
End Connections	Tri-Clamp
Cv (Kv) & Flow Characteristic	0.2 - 165 Cv (0,17 - 200 Kv), Linear or Equal Percentage
Max Pressure/Temperature	450 psi (31 bar) at 100°F (38°C) for 1/2" - 3"; 250 psi (17 bar) at 100°F (38°C) for 4"
Wetted Material & Surface Finish	ASTM SA479 316L or 1.4435 SST; ASME BE SF5, 20 Ra (0,5 µm) electropolish is standard, 8 Ra (0,2 µm) optional
Stem Seal - O-ring	Various - all certified to FDA/USP Class VI

Pressure Regulating Valves Low to High Flows



Angle style or inline pressure reducing valves with bolted body for purified water, clean utilities and media in the biopharmaceutical, pharmaceutical, food & beverage and consumer health & beauty industries. Also available with a tri-clamp body for low flow and an automated or hybrid version.

- » Media prep: AWFI (ambient WFI) or buffer dilution
- » Bioreactor/fermenter process input control: AWFI
- » Separation input and output control: AWFI
- » Purification input and output control: AWFI, Buffer
- » Clean utilities: USP PW, WFI, CIP, CCA, CCG

MARK 96C SERIES, TRI-CLAMP, LOW FLOW, MANUAL, JORLON™ DIAPHRAGM

Sizes	1/2", 3/4", 1" (DN15, DN20, DN25)
End Connections	ASME, DIN & ISO Tri-Clamp, Extended Tube Weld
Cv (Kv) & Flow Characteristic	0.3 - 5.5 Cv (0,26 - 4,7 Kv)
Max Pressure/Temperature	Dependent upon construction
Setpoint Range	3 psi (0,2 bar) to 135 psi (9,3 bar); dependent on size of construction
Wetted Material & Surface Finish	ASTM SA479 316L or 1.4435 SST; ASME BPE SF5, 20 Ra (0,5 µm) electropolish is standard, 8 Ra (0,2 µm) optional
Diaphragm Materials	Jorlon™ FDA, USP Class VI; EPDM/Nylon - FDA only
Soft Seat Option	Jorlon™, PEEK, Teflon (all materials FDA, USP Class VI)

MARK 96 SERIES, MANUAL, MEDIUM TO HIGH FLOW, JORLON™ DIAPHRAGM

Sizes	3/4" - 3" (DN20 - DN80)
End Connections	ASME, DIN & ISO Tri-Clamp, Extended Tube Weld
Cv (Kv) & Flow Characteristic	1.5 - 23 Cv (1,3 - 19,8 Kv)
Max Pressure/Temperature	Dependent upon construction
Setpoint Range	3 psi (0,2 bar) to 135 psi (9,3 bar); dependent on size and construction
Wetted Material & Surface Finish	ASTM SA479 316L or 1.4435 SST; ASME BPE SF5, 20 Ra (0,5µm) electropolish is standard, 8 Ra (0,2µm) optional
Diaphragm Materials	Jorlon™ FDA, USP Class VI; EPDM/Nylon (FDA only)
Soft Seat Option	Jorlon™, PEEK, Teflon (all FDA and USP Class VI)

MARK 96A & 96AA SERIES HYBRID OR AUTOMATED, JORLON™ DIAPHRAGM

Sizes	3/4" - 3" (DN20 - DN80)
End Connections	ASME, Tri-clamp, ASME Butt Weld, ASME Tube Weld, DIN ISO Tri-Clamp, Tube Weld
Cv (Kv) & Flow Characteristic	1.5 - 23 Cv (1,3 - 19,8 kv) model dependent model dependent
Max Pressure/Temperature	model dependent
Setpoint Range	3 psi (0,2 bar) to 135 psi (9,3 bar); dependent on size and construction
Wetted Material & Surface Finish	ASTM SA479 316L or 1.4435 SST; ASME BE SF5, 20 Ra (0,5 µm) electropolish is standard, 8 Ra (0,2 µm) optional
Diaphragm Materials	Jorlon™ FDA, USP Class VI
Soft Seat Option	Jorlon™, PEEK, Teflon (all materials FDA, USP Class VI)

FB6C SERIES, 3A & FDA APPROVED, JORLON™ DIAPHRAGM

Sizes	3/4" - 3" (DN20 - DN80)
End Connections	Tri-Clamp
Cv (Kv) & Flow Characteristic	0.6 - 29.4 Cv (0,5 - 25,4 Kv)
Max Pressure/Temperature	450 psi (31 bar) at 100°F (38°C) for 1/2" - 3"; 250 psi (17 bar) at 100°F (38°C) for 4"
Body Materials	ASTM A351, CF3M 316L
Seat Materials	Standard hard seat - integral 316L SST seat; optional soft seats: Jorlon™ (FDA & USP Class VI) for steam and hot fluid service to 338°F (170°C), Cv 0.5 and larger only; PEEK (FDA & USP Class VI) for steam and hot fluid service to 350°F (177°C), Cv 0.5 and larger; PTFE (FDA & USP Class VI) to 252°F (122°C) continuous or 275°F (135°C) intermittent (not to exceed 15 min. in a one hour period), Cv 0.5 and larger

Back Pressure Regulating Valves Low to High Flows



Angle style, flow-through or inline back pressure reducing valves for purified water, clean utilities and media in the biopharmaceutical, pharmaceutical, food & beverage and consumer health & beauty industries.

- » WFI distribution loop: return loop pressure maintenance upstream of spray ball
- » Media / buffer prep, upstream process: input back pressure control for mixing buffer, media; pressure maintenance and relief to sterile containment
- » Separation input and output control: for perfusion TFE, for TransMembrane Pressure (TMP) control
- » Purification input and output control: for chromatography column, TFE or depth filtration differential pressure control; pump head pressure maintenance or pressure bypass; agitator or pump seal water pressure maintenance

MARK 95 SERIES, LOW TO HIGH FLOW, JORLON™ DIAPHRAGM

Sizes	1/2" - 3" (DN15 - DN80)
End Connections	ASME, Tri-clamp, ASME Tube Weld, DIN ISO Tri-Clamp, Tube Weld
Cv (Kv) & Flow Characteristic	0.5 - 28 Cv (0,4 - 24,1 Kv)
Max Pressure/Temperature	Dependent upon construction
Setpoint Range	3 psi (0,2 bar) to 90 psi (6,2 bar); dependent on size of construction
Wetted Material & Surface Finish	ASTM SA479 316L or 1.4435 SST; ASME BPE SF5, 20 Ra (0,5 µm) electropolish is standard, 8 Ra (0,2 µm) optional
Diaphragm Materials	Jorlon™ FDA, USP Class VI, 316L, EPDM/Nylon (FDA only)
Soft Seat Option	Jorlon™, PEEK, Teflon (all materials FDA, USP Class VI)

MARK 95FT SERIES, MANUAL, FLOW-THROUGH BODY, LOW TO HIGH JORLON™ DIAPHRAGM

Sizes	1/2" - 3" (DN15 - DN80)
End Connections	ASME, Tri-clamp, ASME Tube Weld, DIN ISO Tri-Clamp, Tube Weld
Cv (Kv) & Flow Characteristic	0.5 - 28 Cv (0,4 - 24,1 Kv)
Max Pressure/Temperature	Dependent upon construction
Setpoint Range	3 psi (0,2 bar) to 90 psi (6,2 bar); dependent on size and construction
Wetted Material & Surface Finish	ASTM SA479 316L or 1.4435 SST; ASME BPE SF5, 20 Ra (0,5µm) electropolish is standard, 8 Ra (0,2µm) optional
Diaphragm Materials	Jorlon™ FDA, USP Class VI, 316L, EPDM/Nylon (FDA only)
Soft Seat Option	Jorlon™, PEEK, Teflon (all materials FDA and USP Class VI)

MARK 95A & 95AA SERIES HYBRID OR AUTOMATED, LOW TO HIGH FLOW, JORLON™ DIAPHRAGM

Sizes	1/2" - 3" (DN15 - DN80)
End Connections	ASME, Tri-clamp, ASME Tube Weld, DIN ISO Tri-Clamp, Tube Weld
Cv & Flow Characteristic	0.5 - 28 Cv (0,4 - 24,2 kv)
Setpoint Range	3 psi (0,2 bar) to 90 psi (6,2 bar); dependent on size and construction
Wetted Material & Surface Finish	ASTM SA479 316L or 1.4435 SST; ASME BE SF5, 20 Ra (0,5 µm) electropolish is standard, 8 Ra (0,2 µm) optional
Diaphragm Materials	Jorlon™, USP Class VI
Soft Seat Option	Jorlon™, PEEK, Teflon (all materials FDA and USP Class VI)

FB5C SERIES, 3A & FDA APPROVED, JORLON™ DIAPHRAGM

Sizes	3/4" - 3" (DN20 - DN80)
End Connections	Tri-Clamp
Cv (Kv) & Flow Characteristic	0.5 - 28 Cv (0,4 - 24,1 Kv)
Diaphragm Materials	EPDM/Nylon to 275°F (135°C) 3A & FDA; Teflon Encapsulated Viton to 400°F (204°C) 3A & FDA; Jorlon™ to 400°F (204°C) 3A & FDA
Body Materials	ASTM A351, CF3M 316L
Seat Materials	Standard hard seat - integral 316L SST seat; soft seats available consult factory

Industrial Compressed Air & Gas Pressure Regulators & Back Pressure Regulators



Back air and gas pressure regulators are designed to handle very high pressures and very low flows. Pressure air and gas regulators handle very high pressures and very low flows, low set pressures and very low flows and piston operated regulators with high Cvs (Kvs).

- » Biopharma research and sampling systems
- » Clean room gas panels and gas distribution
- » Gas chromatography
- » Gas cabinets

JR SERIES, HIGH PRESSURE, LOW FLOW, JORLON™ DIAPHRAGM JB SERIES, HIGH PRESSURE, LOW FLOW, JORLON™ DIAPHRAGM

Sizes	1/4", 3/8" & 1/2" (DN8, DN10 & DN15)
End Connections	Threaded, Socket Weld, Flanged
Cv (Kv)	0.012, 0.03, 0.08, 0.20 (0,01, 0,026, 0,07, 0,17) JR Series; 0.05, 0.15, 0.25, 0.35 (0,04, 0,13, 0,22,0,30) JB Series
Spring Range	up to 750 psi (52 bar)
Seat Type	PTFE (JR Series only), PEEK, KEL-F
Diaphragm Materials	Jorlon™ FDA & USP Class VI

JRDL SERIES, DIAPHRAGM OPERATED, HIGH PRESSURE, LOW FLOWS JBDL SERIES, DIAPHRAGM OPERATED, HIGH PRESSURE, LOW FLOWS

Sizes	1/2", 3/4" & 1" (DN15, DN20 & DN25) JRDL Series; 1/2" (DN15) JBDL Series
End Connections	Threaded, Socket Weld, Flanged
Cv (Kv)	1.7 (1,46) JRDL Series; 1.95 (1,69) JBDL Series
Spring Range	0-50 psi, 0-100 psi 0-200 psi, 0-400 psi (0,0-3,4 bar, 0-6,9 bar, 0-13,8 bar, 0-28 bar) JRDL Series; up to 400 psi JBDL Series
Seat Type	Buna-N, EPDM, Viton JRDL Series; KEL-F JBDL Series

JRH SERIES, MANUAL, VERY HIGH PRESSURE, LOW FLOW, JORLON™ DIAPHRAGM

Size	3/8" & 1/2" (DN10 & DN15)
End Connections	Threaded, Socket Weld, Flanged
Cv (Kv)	0.08, (0.69)
Spring Range	2-10 psi and 75-450 psi (0,14-0,69 bar and 5,2-31 bar)
Seat Type	KEL-F / Viton
Diaphragm Materials	Jorlon™ FDA & USP Class VI

JRHF SERIES, DIAPHRAGM OPERATED, HIGH FLOWS, JORLON™ DIAPHRAGM

Sizes	1/2", 3/4", 1" (DN15, DN20, DN25)
End Connections	Threaded, Socket Weld, Flanged
Cv (Kv)	1/2": 1.5 (1,3 KV); 3/4" - 1": 1.9 (1,6 KV)
Spring Range	up to 150 psil (10 bar)
Seat Type	PTFE, PEEK
Diaphragm Materials	Jorlon™ FDA & USP Class VI

JRHL SERIES, LOW SET PRESSURE, VERY LOW FLOWS, JORLON™ DIAPHRAGM

Sizes	1/2" & 3/4" (DN15 & DN20)
End Connections	Threaded, Socket Weld, Flanged
Cv (Kv)	0.5 & 0.8 (0,43 & 0,7)
Spring Range	up to 50 psi (3,45 bar)
Seat Type	PTFE, PEEK, EPDM
Diaphragm Materials	Jorlon™ FDA & USP Class VI

Compressed Air & Gas Pressure Regulators & Back Pressure Regulators



[Compare](#)

Pharma clean compressed air and gas pressure reducing valves, NPT, Tri-Clamp or weld ends, very low to high flow, manual or air augmented, with Jorlon™ lifetime diaphragm warranty.

- » Bioreactor/fermenter: sparge gas, purge/blanket/motive force gas regulation
- » Separation: purge/blanket/motive force gas regulation for process vessels
- » Purification: purge/blanket/motive force gas regulation for process vessels
- » Formulation: purge/blanket/motive force gas regulation for process vessels
- » Lyophilization: purge/blanket/motive force gas regulation for process vessels

JSR SERIES, MANUAL OR AIR AUGMENTED, LOW TO MEDIUM FLOW, JORLON™ DIAPHRAGM JSB SERIES, MANUAL OR LOW TO MEDIUM, JORLON™ DIAPHRAGM

Sizes	1/2" & 3/4" (DN15 & DN20)
End Connections	ASME BPE, DIN & ISO Tri-Clamp, Tube Weld & NPT (VCR optional)
Cv	0.8 - 0.5 Cv (0,7 - 0,43 Kv)
Max Inlet Pressure	150 psi (10,5 br)
Setpoint Range	5 psi to 125 psi (0,03 bar to 8,6 bar) JSR Series; 8 psi to 125 psi (0,06 bar to 8,6 bar) JSB Series
Diaphragm Materials	Jorlon™ FDA & USP Class VI

JSRH SERIES, MANUAL, MEDIUM TO HIGH FLOW, JORLON™ DIAPHRAGM

Sizes	1/2", 3/4" & 1" (DN15, DN20 & DN25)
End Connections	ASME BPE, DIN & ISO Tri-Clamp, Tube Weld & NPT
Cv (Kv)	1.5, 1.9 Cv (1,3, 1,64 Kv)
Max Pressure/Temperature	150 psi (10,5 bar) at 275°F (135°C)
Setpoint Range	5 psi (0,34 bar) to 150 psi (10,3 bar)
Diaphragm Materials	Jorlon™ FDA & USP Class VI

JSRHF SERIES, MANUAL, MEDIUM TO HIGH FLOW, JORLON™ DIAPHRAGM

Sizes	3/4" - 2" (DN20 - DN50)
End Connections	ASME BPE, DIN & ISO Tri-Clamp, Tube Weld & NPT
Max Operating Temperature	250 psig @ 275°F (10,5 bar @ 135°C)
Max Operating Pressure	300 psi @ 100°F (20,7 bar @ 38°C)
Setpoint Range	5 - 250 psi (0,3 - 17,2 bar)
Diaphragm Materials	Jorlon™ FDA & USP Class VI

JSRLF SERIES, MANUAL OR AIR AUGMENTED, JORLON™ DIAPHRAGM JSBLF SERIES, MANUAL OR AIR LOADED, JORLON™ DIAPHRAGM

Sizes	1/4" - 3/4" (DN8 - DN20) JSRLF Series; 3/8", 1/2" & 3/4" (DN10, DN15 & DN20) JSBLF Series
End Connections	ASME BPE, DIN & ISO Tri-Clamp, Tube Weld & NPT
Cv (Kv)	0.012 and 0.20 (0,01 and 0,17 Kv) JSRLF Series; 0.05, 0.15, 0.25, 0.35 (0,04, 0,13, 0,21, 0,30 Kv) JSBLF Series
Max Pressure/Temperature	450 psi @ 350°F (31,0 bar @ 177°C) with PEEK seats; 450 psi @ 150°F (30,1 bar @ 66°C) with PTFE seats
Setpoint Range	5 psi to 750 psi (0,3 bar to 52 bar) JSRLF Series; 5 psi to 450 psi (0,3 bar to 31 bar) JSBLF Series
Diaphragm Materials	Jorlon™ FDA & USP Class VI

JSRLFLP SERIES, MANUAL OR AIR AUGMENTED, LOW FLOW & PRESSURE, JORLON™ DIAPHRAGM JSBLFLP SERIES, LOW FLOW, LOW PRESSURE, JORLON™ DIAPHRAGM

Size	1/4", 3/8", 1/2", 3/4" (DN8, DN10, DN15, DN20) JSRLFLP Series; 3/8", 1/2", 3/4" (DN10, DN15, DN20) JSBLFLP Series
End Connections	ASME BPE, DIN & ISO Tri-Clamp, Tube Weld & NPT
Cv (Kv)	0.012 and 0.20 (0,01 and 0,17 Kv) JSRLFLP Series; 0.05, 0.15, 0.25, 0.35 (0,04, 0,13, 0,21, 0,30 Kv) JSBLFLP Series
Max Pressure/Temperature	Tube & Tri-Clamp: 150 psi @ 350°F (10,3 bar @ 177°C) with PEEK seats; 150 psi @ 150°F (10,3 bar @ 66°F) with PTFE seats JSRLFLP Series; 250 psig (10,5 barg) for weld end or tri-clamp connections; 450 psig (31 barg) for NPT connections JSBLFLP Series
Setpoint Range	1 psi to 50 psi (0,07 bar to 3,4 bar)
Diaphragm Materials	Jorlon™ FDA & USP Class VI

Low Pressure Air & Gas Blanketing Regulators



Pharma clean compressed air and gas blanketing (gas overlay) regulators (PRV, BPRV), very low flow to high flow, very low pressure set points and manual control

- » Separation: purge/blanket/motive force gas regulation and bag integrity testing for process vessels
- » Purification: purge/blanket/motive force gas regulation and bag integrity testing for process vessels
- » Formulation: purge/blanket/motive force gas regulation and bag integrity testing for process vessels
- » Single-use bag inflation

MARK 908/908X SERIES, MID TO HIGH FLOW, VERY LOW PRESSURE

Sizes	3/4" & 1" (DN20 & DN25) Mark 980 Series; 1/2" & 3/4" (DN15 & DN20) Mark 908X Series
End Connections	ASME BPE, DIN & ISO Tri-Clamp, Flanged or NPT
Cv (Kv)	1.0 - 10 (0,86 - 8,65) Mark 908 Series; 0,15, 0,2, 0,4 (0,13, 0,17, 0,35) Mark 908X Series
Max Pressure/Temperature	Maximum inlet: 200 psi @ 250°F (13,8 bar @ 121°C)
Setpoint Range	1/2" wc - 1.5 psi (1,25 mbarg - 103,4 mbarg)
Wetted Material & Surface Finish	ASTM SA479 316L or 1.4435 SST; ASME BPE SF5, 20 Ra (0,5 µm)
Diaphragm Material	Ultra-lightweight Teflon FDA compliant
Main Valve Seal Material	EPDM and 316/Viton (all material is FDA compliant)

JSRLFULP SERIES LOW FLOW, LOW PRESSURE, CLEAN GAS REGULATOR

Sizes	1/2" & 3/4" (DN15 & DN20)
End Connections	ASME BPE
Gauge Ports	1/4" FNPT is standard
Soft Seat Materials	EPDM to 275°F (135°C), FDA & USP Class VI
Diaphragm Materials	Jorlon™ FDA & USP Class VI
Spring Ranges	2" - 18" water (0,07 - 0,65 psi)

JSRHULP SERIES, HIGH PURITY, ULTRA LOW PRESSURE REGULATOR

Sizes	1/2", 3/4", 1" (DN15, DN20, DN25)
End Connections	Tri-Clamp
Gauge Ports	1/4" FNPT is standard
Soft Seat Materials	EPDM to 275°F (135°C), FDA & USP Class VI
Diaphragm Materials	Jorlon™ FDA & USP Class VI
Spring Ranges	4" - 18" water (0,14 - 0,65 psi)

MARK 958/968 SERIES MEDIUM TO HIGH FLOW, BPRV/PRV

Sizes	3/4", 1", 1-1/2", 2" (DN20, DN25, DN40, DN50)
End Connections	ASME BPE, DIN & ISO Tri-Clamp, Flanged - 150#, 300#, PN25/40
Flow Ranges	MK958: 368 SCFH to 22,953 SCFH (10 NM ³ /H to 650 NM ³ /H) MK968: 201 SCFH to 19,258 SCFH (5,7 NM ³ /H to 545 NM ³ /H)
Max Pressure/Temperature	Size dependent
Setpoint Range	2.0" w.c. to 5 psi (5 mbar to 344,7 mbar)
Diaphragm Materials	FDA approved Viton
Wetted Material & Surface Finish	Internal and external cast body components are 130 Ra (3,30 µm) minimum after electropolishing
Shutoff	ANSI Class VI

Equilibar FDO Series Sanitary Back Pressure Regulators



Also available in Single Use technology



The Equilibar® FDO Series works differently, with synergistic design features that provide extreme precision, almost instantaneous reaction, frictionless operation, and an exceptionally flexible flow rate range. It is compact, easily automated and can be used for both back pressure control and flow control.

- » Dome-loaded with multiple orifice flow paths with a flexible diaphragm that covers and seals the parallel orifices in the FDO body
- » The diaphragm lifts off the orifices to release pressure as the upstream process pressure exceeds the set-point pressure, accounting for exceptionally wide flow range
- » The flow rangeability and precision at extremely low pressures makes the FDO an excellent choice for transmembrane pressure control in tangential flow filtrations (TFF)

FD SERIES, WIDE FLOW RANGE

Sizes	1/4", 1/2", 3/4", 1", 1-1/2", 2", 3"
End Connections	ASME BPE, DIN & ISO Tri-Clamp, Tube Weld Ends
Cv	1E-6 to 36
Max Pressure	150 psig (10 barg)
Setpoint Range	Depends on process
Wetted Material & Surface Finish	ASTM SA479 316L or 1.4435 SST; ASME BPE SF5, less than 20 Ra (0,5 µm) electropolish
Diaphragm Materials	Jorlon™ USP Class VI, PTFE USP Class VI, EPDM USP Class VI, FKM Flouroelastomer, Buna-N, Glass Reinforced PTFE

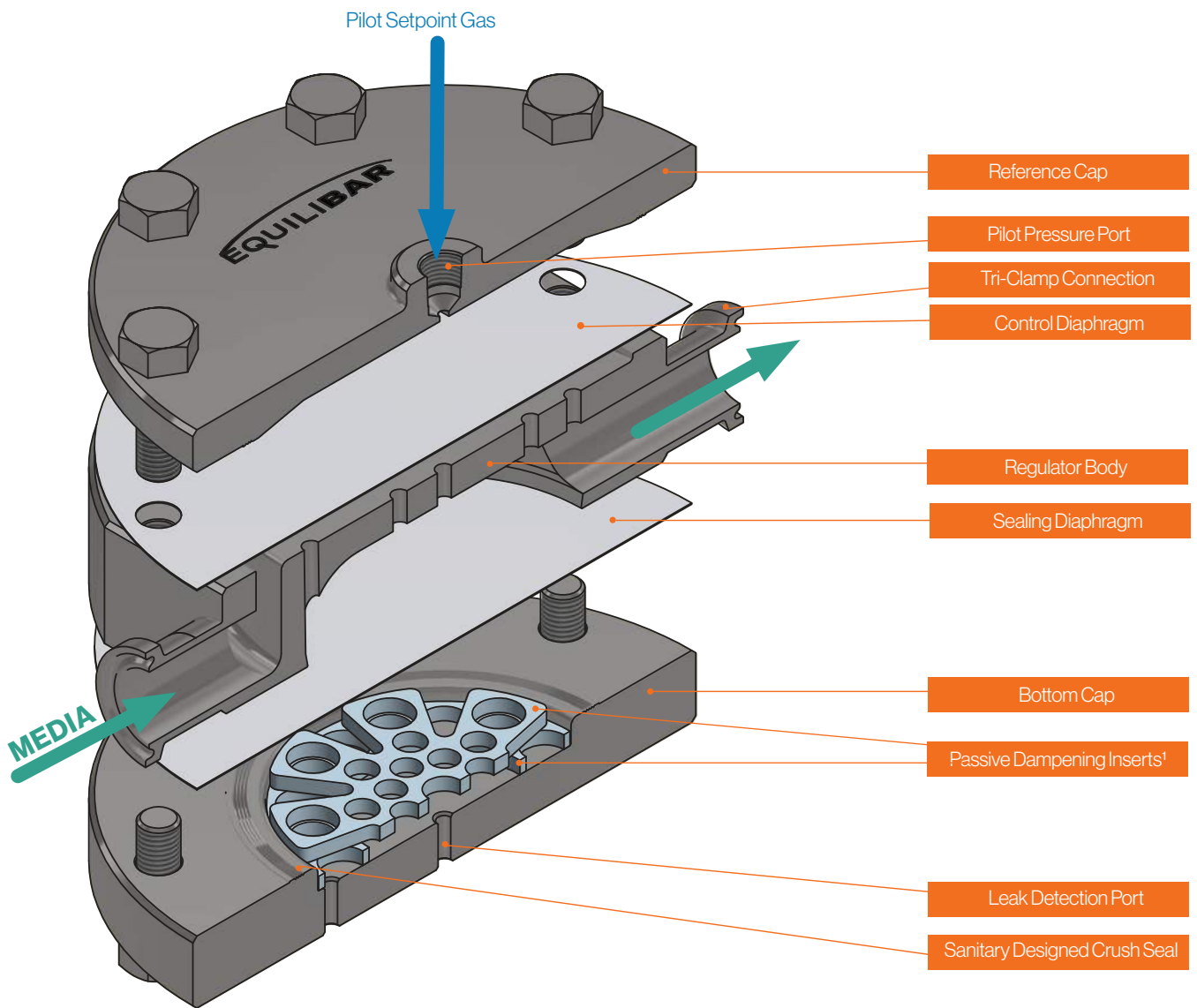

¹Integrated passive dampening is standard in most models to help reduce possible downstream pressure fluctuations due to process equipment such as pumps.

Sanitary Safety Relief Valves



National Board Certified to ASME VIII/XIII. CE/PED Certified. Designed to relieve overpressure upset in hygienic and aseptic process and clean utility systems. They are manually set to open at a predetermined pressure and re-seat after pressure subsides. This protects pressure vessels and other equipment from pressure that exceeds their design limits.

- » Bioreactor: fermenter vessel and vessel jackets
- » Formulation and other pharma process vessels
- » Clean air/gas distribution systems for point of use
- » Clean steam systems
- » WFI and USP PW vessels
- » Any hygienic or aseptic process vessel or system

SSRV 81/81V SERIES, SMALL CAPACITY

Available Connection Size & Type	1/2" - 1" MNPT, FNPT (inlet); 1/2" - 1" FNPT (outlet) 1/2" - 1" ASME BPE Tri-Clamp (inlet); 1/2" - 1" ASME BPE Tri-Clamp (outlet)
Body & Wetted Trim Materials	ASME SA479 316L (UNS 31603), AL6XN, Hasteloy C-22, other materials
Wetted Seat & O-Ring Material	EPDM (o-ring soft seat & vulcanized soft seat) rated to 325°F (163°C) Viton (o-ring soft seat) rated to 400°F (204°C) FDA & USP Class VI Compliant Elastomers EPDM (o-ring soft seat & vulcanized soft seat) rated to 325°F (163°C) Viton (o-ring soft seat & vulcanized soft seat) rated to 400°F (204°C) FFKM (o-ring soft seat) rated to 450°F (232°C)
Body Pressure/Temperature Rating	550 psi @ 450°F (37,9 bar @ 232°C)
Available Setpoint Range	15-232 psi (1,03 - 16 bar) Standard 81 Series; 233 - 500 psi (16,1 - 34,4 bar) High Pressure 81 Series

SSRV 83/83X SERIES, MEDIUM CAPACITY

Available Connection Size & Type	1-1/2" ASME BPE Tri-Clamp (inlet); 2" ASME BPE Tri-Clamp (outlet) 83 Series; 1" ASME BPE Tri-Clamp (inlet); 1-1/2" ASME BPE Tri-Clamp (outlet) 83X Series
Body & Wetted Trim Materials	ASME SA479 316L (UNS 31603), AL6XN, Hasteloy C-22, other materials
Wetted Seat & O-Ring Material	FDA & USP Class VI Compliant Elastomers EPDM rated -49°F to 302°F (-45°C to 150°C) Viton rated to 400°F (204°C) FFKM rated 32°F to 450°F (0° to 232°C)
Body Pressure/Temperature Rating	255 psi @ 450°F steam*, gas, liquid (17,6 bar @ 232°C) * up to 90 psi (6,2 bar)
Available Setpoint Range	15 - 232 (1,03 bar - 16 bar)

SSRV 88 SERIES, LARGE CAPACITY

Available Connection Size & Type	1/2" - 1" MNPT, FNPT (inlet); 1/2" - 1" FNPT (outlet) 1/2" - 1" ASME BPE Tri-Clamp (inlet); 1/2" - 1" ASME BPE Tri-Clamp (outlet)
Body & Wetted Trim Materials	ASME SA479 316L (UNS 31603), AL6XN, Hasteloy C-22, other materials
Wetted Seat & O-Ring Material	FDA & USP Class VI Compliant Elastomers EPDM rated -49°F to 302°F (-45°C to 150°C) Viton rated to 400°F (204°C) FFKM rated 32°F to 450°F (0° to 232°C)
Body Pressure/Temperature Rating	255 psi @ 450°F steam*, gas, liquid (17,6 bar @ 232°C) * up to 90 psi (6,2 bar)
Available Setpoint Range	Water: 15 - 232 psi (1,03 - 16,0 bar); air/gas/steam: 20 - 232 psi (1,37 - 16,0 bar)

Sanitary Diaphragm Valves



Manual or air actuated forged 2-way or cast 2-way, ported and tandem valves. Barstock zero static T-block, point of use T-block, divert tank bottom and custom block body valves.

- » Well suited to control the flow of corrosive materials and avoid contamination of product within many processes around clean utilities, WFI, and many purified water applications
- » Ideal for industries that require a high degree of fluid purity and cleanliness in the pharmaceutical processing industries

VALVE TYPE BY APPLICATION

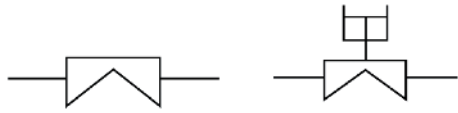

2-WAYS

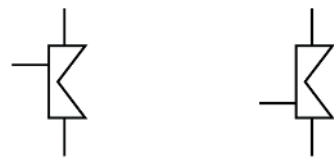

PORTED

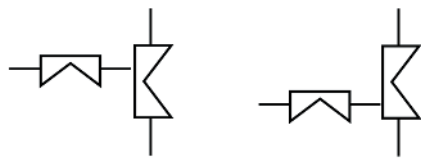

TANDEM ACCESS

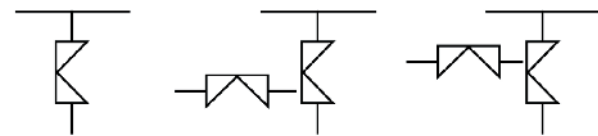

ZERO STATIC T-BLOCK

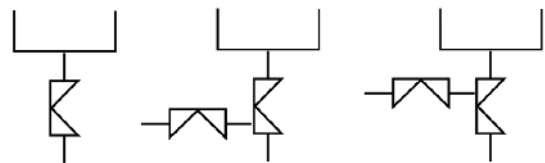

ZERO STATIC POU

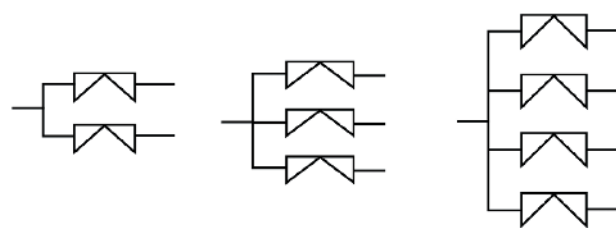

DIVERT BLOCK

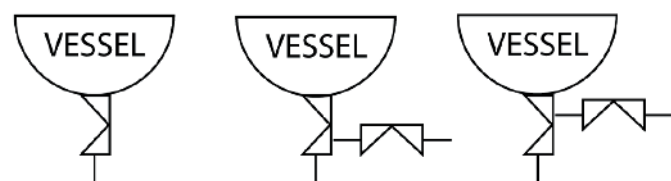

TANK BOTTOM

Sanitary Check Valves



SVC Series



SHC Series

Two piece, spring-less horizontal line sanitary check valves and two piece, spring-less sanitary disc check valves for vertical up-flow for bioprocess media and purified water applications for the biopharmaceutical, pharmaceutical, and consumer health & beauty industries.

- » WFI loop: non-return at pump out
- » Media/buffer prep: back flow prevention during dilution
- » Upstream process: sparge line back flow prevention
- » Separation: centrifuge waste line back flow prevention
- » Purification, chromatography: waste line back flow prevention
- » Pump head pressure maintenance or pressure bypass

SVC SERIES, VERTICAL LINE UP-FLOW, LOW TO HIGH FLOW

Sizes	1/2" - 3" (DN15 - DN80)
End Connections	ASME, DIN, ISO Tri-Clamp, and Tube Weld Ends
Cv (Kv)	3.5 - 58.6 (3,03 - 50,7 Kv)
Wetted SS Material	ASTM A479 316L or optional DIN 1.4435
Disc Material	316/EPDM, Teflon, PEEK (all materials FDA and USP Class VI)
Gasket Material	Various (all materials FDA and USP Class VI)
Max Pressure Temperature	230 psi @ 100°F (16 bar @ 38°C) max temperature dependent on disc and gasket material
Cracking (opening) Pressure	Polymer Discs: 0.04 psid (2,76 millibar); 316/EPDM: 0.13 psid (9,76 millibar)
Metallic Surface Finish	Wetted parts: ASME BPE SF 20Ra (0,5 µm) electropolished; standard: 8 Ra (0,2 µm) electropolished optional

SVC SERIES, VERTICAL LINE DOWN, FOR DRAIN LINES, LOW TO HIGH FLOW

Sizes	1/2" - 3" (DN15 - DN80)
End Connections	ASME, DIN, ISO Tri-Clamp, and Tube Weld Ends
Cv (Kv)	3.5 - 58.6 (3,03 - 50,7 Kv)
Wetted SS Material	ASTM A479 316L or optional DIN 1.4435
Disc Material	Polypropylene (all materials FDA and USP Class VI)
Gasket Material	Various (all materials FDA and USP Class VI)
Max Pressure Temperature	230 psi @ 100°F (16 bar @ 38°C) max temperature dependent on disc and gasket material
Cracking (opening) Pressure	Trap is always open, will only close if water based liquid rises in outlet drain line
Metallic Surface Finish	Wetted parts: ASME BPE SF 20Ra (0,5 µm) electropolished; standard: 8 Ra (0,2 µm) electropolished optional

SHC SERIES, HORIZONTAL LINE, LOW TO HIGH FLOW

Sizes	1/2" - 2" (DN15 - DN50)
End Connections	ASME, DIN, ISO Tri-Clamp, and Tube Weld Ends
Cv (Kv)	3.4 - 23.1 (2,94 - 20 Kv)
Wetted SS Material	ASTM A479 316L or optional DIN 1.4435
Disc Material	316/EPDM, Teflon, PEEK (all materials FDA and USP Class VI)
Gasket Material	Various (all materials FDA and USP Class VI)
Max Pressure Temperature	230 psi @ 100°F (16 bar @ 38°C) max temperature dependent on disc and gasket material
Cracking (opening) Pressure	Polymer Discs: 0.04 psid (2,76 millibar); 316/EPDM: 0.13 psid (9,76 millibar)
Metallic Surface Finish	Wetted parts: ASME BPE SF 20Ra (0,5 µm) electropolished; standard: 8 Ra (0,2 µm) electropolished optional

Sanitary Steam Traps & Accessories



Two piece tri-clamp body, balanced port, low to high flow, thermostatic sanitary steam traps with vertical or horizontal inlet and outlet connections for pure steam SIP and loop drainage applications in biopharmaceutical and certain consumer health and beauty industries.

- » Up and downstream process vessel: small to medium sized vessel or large vessel bypass loop trap, validated SIP drainage
- » Up and downstream process: validated and high flow validated SIP tubing drain
- » Sterile filter: validated SIP condensate drain from filters; large vent and product filters validated SIP tubing drain
- » Clean steam distribution loop: loop drainage and point of use PCV drainage
- » Clean steam humidification drainage in air handlers

MARK 93 SERIES, MEDIUM TO HIGH FLOW, CLEAN STEAM TRAP

MARK 93JR SERIES, COMPACT, LOW TO MEDIUM FLOW, CLEAN STEAM TRAP

Sizes	1/2", 3/4", 1", 1-1/2" (DN15, DN20, DN25, DN40) MK93 Series; 1/4", 1/2", 3/4", 1" (DN8, DN15, DN20, DN25) MK93JR Series
Installation Connection Orientation	Vertical, Horizontal (MK93 Series only)
Connection Type:	ASME, DIN, ISO Tri-Clamp and Tube Weld Ends
Max Pressure/Temperature	145 psig @ 350°F (10 barg @ 177°C)
Max Recommended Differential Pressure	10 - 50 psi (0,7 - 3,4); Mark 93P option: 45 - 90 psi (3,1 - 6,2 bar) MK93 Series; 0 - 100 psi (0,7 - 6,9 bar) MK93JR
Materials of Construction	Wetted body/plug material: ASTM SA479 316L or optional DIN 1.4435; Body Gaskets: various, all FDA and USP Class VI
Nominal Cv (Kv)	3.8 Cv (3,30 Kv) Mark 93 Series; Cold water 1.31 Cv (1,13 Kv) Mark 93JR Series
Subcooling	Less than 3°F (1,7 °C) Mark 93 Series

MARK 94 SERIES, HIGH FLOW, CLEAN STEAM TRAP

Sizes	3/4", 1", 1-1/2" (DN20, DN25, DN40)
Installation Connection Orientation	Vertical, Horizontal
Connection Type:	ASME, DIN, ISO Tri-Clamp and Tube Weld Ends
Max Pressure/Temperature	145 psig @ 350°F (10 barg @ 177°C)
Max Recommended Differential Pressure	50 psi (3,4 barg)
Materials of Construction	Wetted body/plug material: ASTM SA479 316L or optional DIN 1.4435; Body Gaskets: various, all FDA and USP Class VI
Nominal Cv (Kv)	4.0 Cv (3,4 Kv)
Subcooling	Less than 3°F (1,7 °C)

MARK 9020 SERIES BALL VALVES

Sizes	1/2" - 4" (DN15 - DN100)
End Connections	ASME BPE, Tri-Clamp or extended tube weld ends, DIN 11866-A or B (ISO) extended tube weld ends std
Max Pressure/Temperature	to 1000 psig @ 100°F (68,9 barg @ 38°C); 500 psig @ 295°F (34, barg @ 146°C)
Seat & Seal Material	TFM 1600 non-cavity filler seats and all seals FDA, USP <88> Class VI and USP <87>
Wetted Material & Surface Finish	ASTM SA351 CF3M with <3% or 1% ferrite SF1, 20 Ra (0,5µm) machined polished standard, SF4, 15 Ra (0,4µm) electropolish optional

SSC SERIES, CLEAN STEAM SUBCOOLED CONDENSER

Connection Size/Type	3/4" ASME BPE Tri-Clamp end connections
Max Operating Pressure	145 psig (10 barg) Note: drain system maximum operating pressure is determined by attached steam trap
Materials of Construction	Wetted material: ASTM SA479 316L or DIN 1.4435
Surface Finish	Capacity dependent on trap attached to outlet. Unit cools condensate before steam trap enabling the bellows to contract, opening orifice further
Radiant and Convective Heat Loss	Cools entering condensate by an average 30°F at ambient temperatures



Please visit our website to see our full range of Clean Steam Traps & SIP Accessories





A Division of Richards Industrials
3170 Wasson Road, Cincinnati, OH 45209

1.513.533.5600
steriflow@richardsind.com
steriflowvalve.com



A Division of Richards Industrials
320 Rutledge Road, Fletcher, NC 28732

1.828.650.6590
inquiry@equilibar.com
equilibar.com

