

SANITARY DIAPHRAGM VALVES

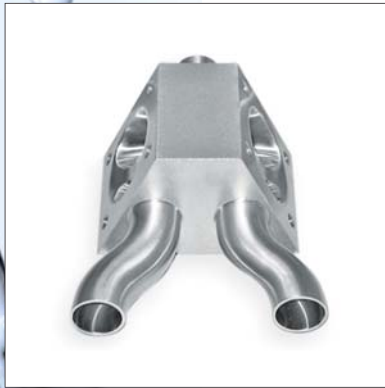

Full line of quality diaphragm valves
for the Bio-Pharmaceutical industry

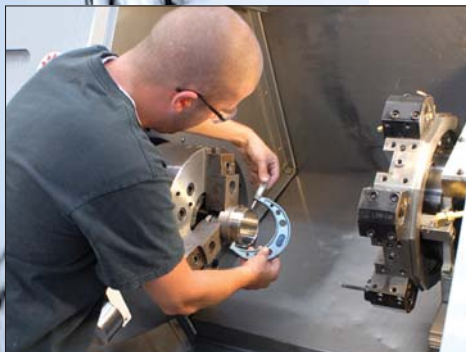

WELCOME TO MBF STAINLESS VALVES.

In today's rapidly changing economic arena, companies may lose sight of the most critical element of the business chain. The customer.

With that in mind, our goal is to provide you with highest quality products, innovative design solutions, and uncompromised **CUSTOMER SERVICE**. Our business concept is driven by the needs & ideas of our partners and associates.

Our team of dedicated personnel has decades of proven design and engineering expertise. We have the luxury of an ultra modern manufacturing facility equipped with integrated CAD/CAM systems, continuous 5 axis machining, cutting edge R&D software (ANSYS®), comprehensive testing, and class 100 clean packaging. Our innovative docu-LINK™ data retrieval system allows us to help you be more responsive to your customers.

We will provide you with a complete standard product line, as well as custom engineered solutions to meet your specific requirements in a timely manner.

We look forward to working with you!

David Balasubramanian
President

TABLE OF CONTENTS

• Standard Forged Valves	- 1
• Compact Forged Valves	- 2
• Specialty Valves	- 3
• Actuation	- 5
• Bonnets	- 6
• Diaphragms	- 7
• Technical & Ordering	- 8



Certificat no. 012789 ISO 9001-2000

STANDARD FORGED VALVES



MBF Standard Forged diaphragm valve bodies are integrally forged in ASTM 316L/DIN 1.4435 stainless, with Clamp, Tube or custom ends. Our materials are controlled to ASME BPE standards and our forgings are solution annealed to maintain a ferrite level below 5%. MBF bodies, in compliance with FDA guidelines and Good Manufacturing Practices, are specifically suited for use in ultra pure applications.

Precision machining of contours and profiles is performed on our state-of-the-art 5 axis CNC machines using specialized software for accuracy and finish. This technology assures repeatability, minimum handling, and proper drainability. Our standard BPE finishes, SFV1 (20Ra) & SFV5 (EP), are verified by profilometer.

Throughout the manufacturing process, we maintain material and process traceability in compliance with ISO 9001-2000. Each body is clearly identified and traceable to the original MTR and other related documents.

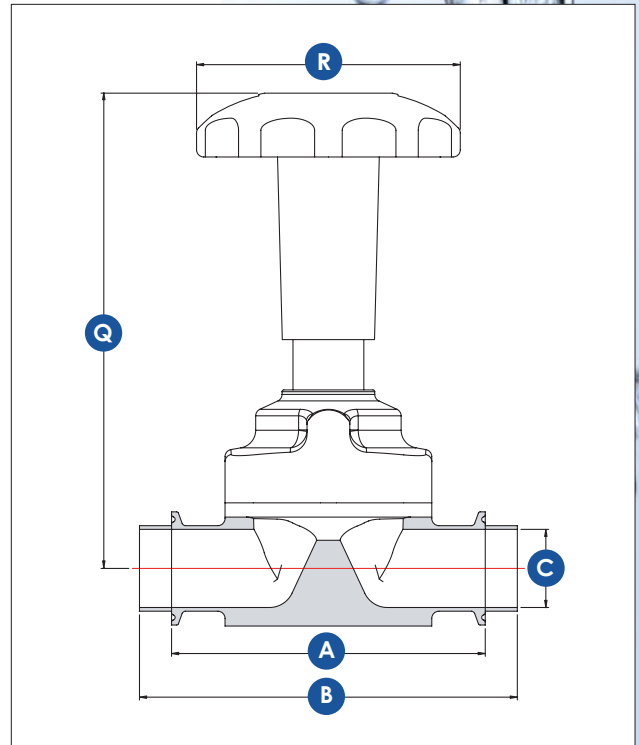

STANDARD FORGED BODY DIMENSIONS				
	A	B	C	
SIZE	CLAMP	TUBE	ID	CLAMP SIZE
1/2	3.50	4.25	0.37	3/4
3/4	4.00	4.63	0.62	3/4
1	4.50	5.00	0.87	1 1/2
1 1/2	5.50	6.25	1.37	1 1/2
2	6.25	7.25	1.87	2
2 1/2	8.25	9.25	2.37	2 1/2
3	8.75	10.00	2.87	3
4	11.50	12.50	3.83	4

See the Bonnets section for dimension Q and R.
All dimensions are shown in inches.

COMPACT FORGED VALVES

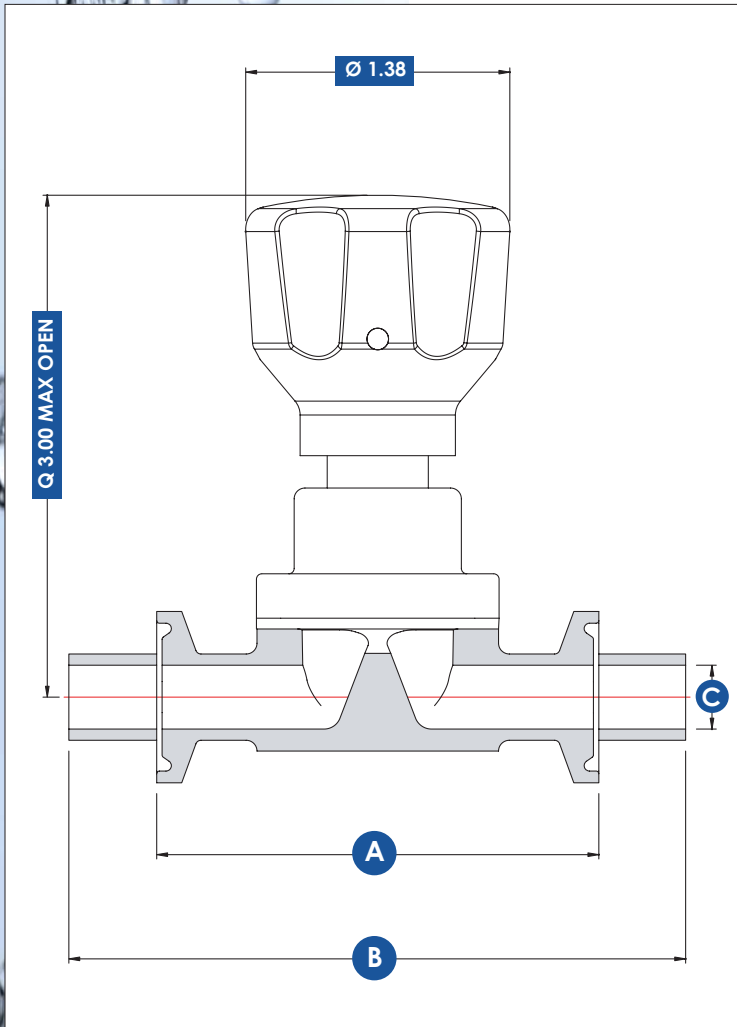

MBF Compact Forged valves are designed to meet the requirements of high purity systems for sampling, drain ports, steam ports and specialty applications.

Compact bodies are integrally forged in ASTM 316L/DIN 1.4435 stainless and meet BPE standards for sulfur content and low ferrite levels. These are available with Clamp, Tube, or custom ends including hose barb and extended tubes.

The fully sealed stainless steel manual bonnet is patented and includes an adjustable closing stop and high performance autoclavable plastic handwheel. We also offer an automated version with pneumatic actuation.

Compact Forged valves are available on ZST, Tandem and Point of Use configurations.

COMPACT FORGED VALVE DIMENSIONS

	A	B	C	
SIZE	CLAMP	TUBE	ID	CLAMP SIZE
1/4	2.56	4.40	0.180	3/4
3/8	2.56	4.40	0.305	3/4
1/2	2.56	4.40	0.370	3/4

Above dimensions are for reference only.
All dimensions are shown in inches.

SPECIALTY VALVES

MBF excels in the design and manufacturing of specialized components for hygienic processes. Our manufacturing facility boasts extensive testing equipment for steam cycling, flow and Cv calibration. Modern continuous 5 axis machining centers compliment our engineering & development in the fabrication of your specialty valves.

Specialty valves are made according to BPE specifications in 316L SS for low sulfur and ferrite levels. We provide our customers with custom drawings to verify function, form and fit prior to manufacturing. This, coupled with our highly flexible manufacturing capability, assures you the best service available.

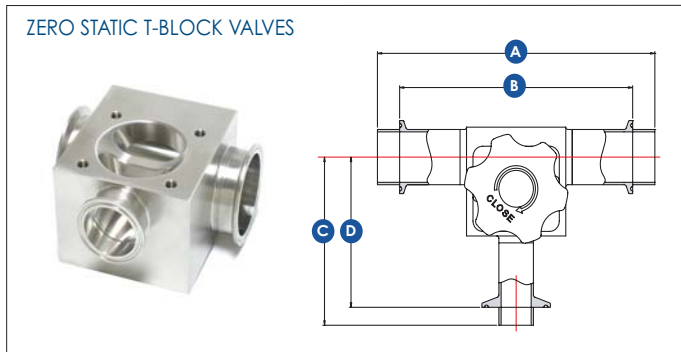

T-BLOCK DIMENSIONS

RUN SIZE	DROP VALVE	TUBE	CLAMP	TUBE	CLAMP
		A	B	C	D
1/2	1/2	5.375	3.375	2.918	1.918
3/4	1/2	5.375	3.375	3.045	2.045
	3/4	5.875	3.875	3.285	2.285
1	1/2	5.375	4.625	3.170	2.170
	3/4	5.875	5.125	3.410	2.410
	1	6.250	5.500	3.578	3.203
1 1/2	1/2	5.375	4.625	3.420	2.420
	3/4	5.875	5.125	3.657	2.657
	1	6.250	5.500	3.830	3.455
	1 1/2	7.375	6.625	4.405	4.030
2	1/2	5.375	4.625	3.670	2.670
	3/4	5.875	5.125	3.907	2.907
	1	6.250	5.500	4.080	3.705
	1 1/2	7.375	6.625	4.654	4.279
	2	8.375	7.625	5.086	4.711
2 1/2	1/2	5.375	4.625	3.920	2.920
	3/4	5.875	5.125	4.158	3.158
	1	6.250	5.500	4.330	3.955
	1 1/2	7.375	6.625	4.904	4.529
	2	8.375	7.625	5.331	4.956
	2 1/2	9.125	8.375	5.819	5.444
3	1/2	5.875	4.625	4.170	3.170
	3/4	6.375	5.125	4.408	3.408
	1	6.750	5.500	4.580	4.205
	1 1/2	7.875	6.625	5.154	4.779
	2	8.875	7.625	5.581	5.206
	2 1/2	9.625	8.375	6.070	5.695
	3	11.375	10.125	6.817	6.192
4	1/2	8.375	4.625	4.652	3.652
	3/4	8.875	5.125	4.890	3.890
	1	9.250	5.500	5.063	4.688
	1 1/2	10.375	6.625	5.633	5.258
	2	11.375	7.625	6.062	5.687
	2 1/2	12.125	8.375	6.553	6.178
	3	13.875	10.125	7.299	6.674
	4	15.375	11.625	8.987	8.112

See the Bonnets section for dimension Q and R.
All dimensions are shown in inches.

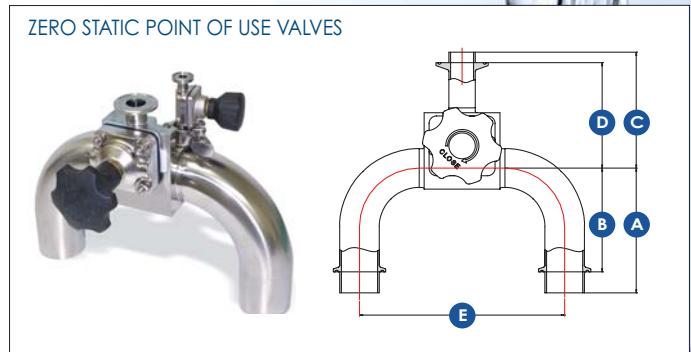

POINT OF USE DIMENSIONS

RUN SIZE	DROP VALVE	CENTER TO CENTER	TUBE	CLAMP	
		E	A	B	
1	1/2	5.375	3.000	2.625	
	3/4	5.875	3.000	2.625	
	1	6.250	3.000	2.625	
1 1/2	1/2	6.875	3.750	3.375	
	3/4	7.375	3.750	3.375	
	1	7.750	3.750	3.375	
	1 1/2	8.875	3.750	3.375	
2	1/2	8.375	4.500	4.125	
	3/4	8.875	4.500	4.125	
	1	9.250	4.500	4.125	
	1 1/2	10.375	4.500	4.125	
	2	11.375	4.500	4.125	
2 1/2	1/2	9.875	5.250	4.875	
	3/4	10.375	5.250	4.875	
	1	10.750	5.250	4.875	
	1 1/2	11.875	5.250	4.875	
	2	12.875	5.250	4.875	
	2 1/2	13.625	5.250	4.875	
	3	15.125	5.250	4.875	
3	1/2	11.375	6.000	5.625	
	3/4	11.875	6.000	5.625	
	1	12.875	6.000	5.625	
	1 1/2	13.375	6.000	5.625	
	2	14.375	6.000	5.625	
	2 1/2	15.125	6.000	5.625	
	3	16.875	6.000	5.625	
	4	1/2	14.375	7.500	7.125
		3/4	14.875	7.500	7.125
1		15.250	7.500	7.125	
1 1/2		16.375	7.500	7.125	
2		17.375	7.500	7.125	
2 1/2		18.125	7.500	7.125	
3		19.875	7.500	7.125	
4		21.375	7.500	7.125	

See the Bonnets section for dimensions Q and R.

See the Zero Static T-Block for dimensions C and D.



TANK BOTTOM DIMENSIONS

SIZE	A	B
1/2	3.00	0.50
3/4	3.50	0.50
1	4.50	0.50
1 1/2	5.50	0.56
2	7.00	0.50
2 1/2	9.00	0.75
3	10.00	0.75
4	14.00	1.00

See the Bonnets Section for dimensions Q and R.
 Dimensions C and D according to BPE or as specified.
 All dimensions are shown in inches.

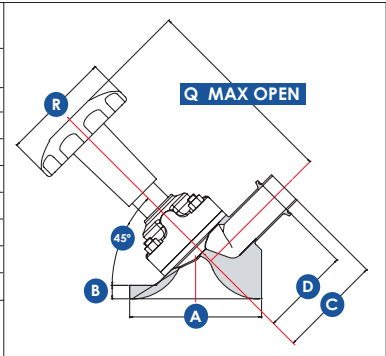

PORTED VALVES

Ported valves provide access to the interior of the valve body at the lowest possible cross section when the body is oriented at the optimal drain angle. The access port in Clamp, Tube, or custom end, can be used for sampling, steam sterilization, purging or condensate drainage. Final configuration detail is confirmed with you prior to fabrication.



TANDEM ACCESS VALVES

Tandem access valves provide access to the interior of the valve body at the lowest possible cross section with the body oriented at the optimal drain angle. The access port includes a valve which can be used for sampling, steam sterilization, purging or condensate drainage. Either custom designed, or selected from standard Tandem Configurations on page 8, configuration detail is confirmed with you prior to fabrication.



MULTI BLOCK DISTRIBUTION VALVES

Multi-Block configurations are custom designed for processes where compact size, cleanliness, full drainability and reduced dead leg are required. MBF has the experience and technology to properly design, manufacture and test these solutions in a timely manner. Configuration detail is confirmed with you prior to fabrication.



DIVERT VALVES

MBF's patented Divert valve in 316L offers exceptional drainage and optimal flow rates due to the fully swept flow path. Instrumental in achieving efficient and cost effective piping design, Divert valves allow process fluids to be diverted, mixed or sampled. These are available from 1/2" to 3" in several combinations of outlets and sizes.

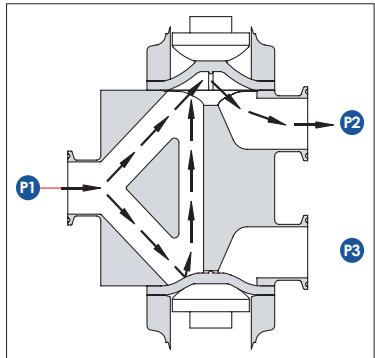

US PATENT 6,024,123

ACTUATION



MBF offers two types of pneumatic actuators for your automation requirements. These actuators are robust, reliable and can be easily mounted on all MBF sanitary valves.

Available with switch packages for on/off control or with positioners for flow control and modulation, these devices are easily interfaced with control systems and fieldbus. MBF actuators are available in spring to close, spring to open and double acting variations.

Features of the new MBF ECLIPSE™ Patent Pending

- Full stainless steel construction with polyamide option
- Two actuators cover complete range of 1/2" to 2"
- Actuator flips for easy function change
- Process stays sealed for actuator removal – NO sterilization
- Swivel feature allows 360° orientation of air inlet
- Standard North American connections – NPT
- Stainless steel base standard for all configurations
- Modular design means less inventory, more flexibility



- Polyamide option available

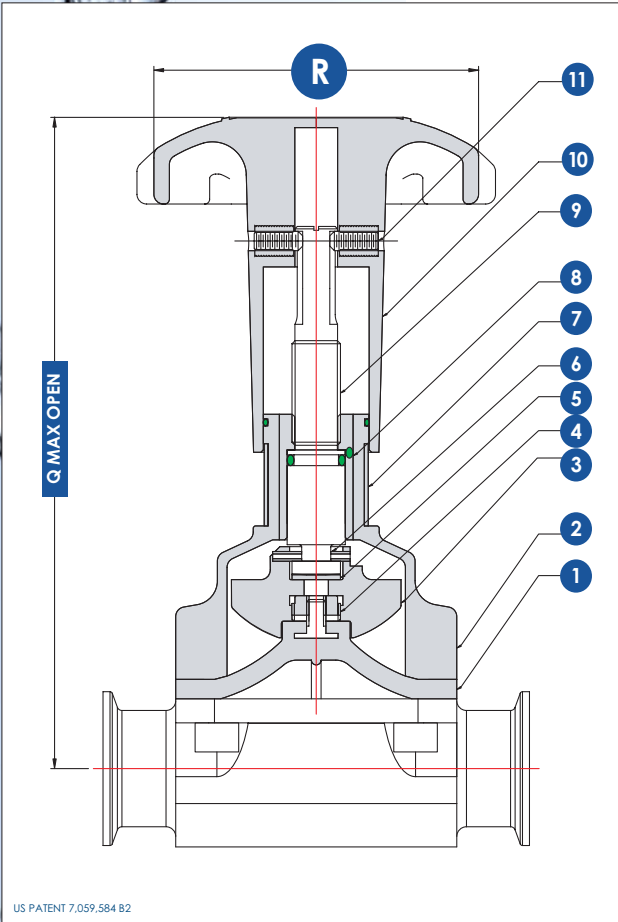

US PATENT 7,059,584 B2

MBF sanitary manual bonnets are the best option when sterile environments are required. The all-stainless bonnet is made from high-quality investment casting that is electro polished to provide a smooth outside surface finish. Fully encased bolting ensure no entrapment of cleaning and autoclave fluids. The hand wheel is made from high performance plastic designed for operation at elevated temperatures.

With a size range of 1/2" to 4" the bonnet assembly is fully sealed and comes standard with an adjustable closing stop and bright visual indicator. MBF Bonnets are available with proximity switches, locking devices and are easily fitted with an optional stroke limiter when required. They are also suitable for the dairy industry in that they meet 3A requirements.

BONNET DIMENSIONS

SIZE	Q	R
1/2	4.47	2.38
3/4	5.00	2.38
1	5.69	2.38
1 1/2	8.47	4.38
2	9.88	4.38
3	10.29	8
4	13.89	10

All dimensions are shown in inches.

BONNET BOM

ITEM	DESCRIPTION	MATERIAL
1	DIAPHRAGM	SEE DIAPHRAGM SECTION
2	BONNET	STAINLESS STEEL
3	COMPRESSOR	STAINLESS STEEL
4	INSERT	BRASS
5	THRUST WASHER	PTFE
6	COMPRESSOR PIN	STAINLESS STEEL
7	INDICATOR	POLYOLEFIN
8	BUSHING	BRASS
9	STEM	STAINLESS STEEL
10	HANDWHEEL	PPS (1/2" TO 2") STAINLESS STEEL (2 1/2" TO 4")
11	SET SCREW	STAINLESS STEEL

DIAPHRAGMS



Steam cycle testing of Diaphragms



MBF diaphragms have been developed specifically for Bio Pharmaceutical applications and are highly reliable, clean and offer excellent performance. We perform extensive research and continued development on the materials to ensure that quality is maintained and improved. All the diaphragms are manufactured with complete traceability of material and processes meeting ISO 9001-2000 requirements.

DIAPHRAGM TECHNICAL INFO			
GRADE	MATERIAL	FAHRENHEIT	CELSIUS
D1	EPDM*	-14°F to 266°F	-10°C to 130°C
D2	TFM / EPDM*	-14°F to 266°F	-10°C to 130°C

*150°C for steam sterilisation cycle TFM is a trademark of Dyneon

PEROXIDE CURED EPDM CERTIFICATION & APPROVALS

MBF EPDM compound is fully compliant with FDA CFR Section (21) 177.2600 and has been fully tested and certified in accordance with U.S. Pharmacopoeia Class VI Section (87) in-vitro and Section (88) in-vivo biological reactivity tests by the accredited NAMSA.

EPDM EXTRACTABLES AND PRODUCTION

EPDM compound has been developed and independently tested to have the lowest percentage of extractables, significantly less than similar competitive commercial compounds. MBF EPDM compound is produced in just-in-time batches to meet tight diaphragm production and is stored for very short periods of time to ensure greater reliability of the mechanical properties of the diaphragm after production.

TFM PRODUCTION

MBF TFM diaphragms are manufactured utilizing a unique high pressure molding technique that ensures a higher uniform density that is virtually non-permeable. This process significantly increases the cycle life of the diaphragm under harsh conditions.

TRACEABILITY

All MBF diaphragms are fully traceable to a specific batch of molded compound. Test certificates and compound properties for each specific batch are recorded and maintained within the QA System. Diaphragms are physically identified with the date of manufacture and the compound identification code.

Each MBF diaphragm valve is supplied with your choice of elastomer or TFM/elastomer backed materials. Our diaphragms are completely compliant with the most recent FDA Codes and USP Standards.

Elastomeric diaphragms are molded in the open position, while TFM faced diaphragms are molded in the closed position. All elastomeric diaphragms are attached to the compressor via threaded stud.

MBF TFM faced diaphragms are attached by a bayonet type fixture that eliminates point loading. This provides constant diaphragm compression across the weir resulting in a uniform, reliable seal. Optional TFM faced diaphragms can be supplied with a thread type fixture for interchangeability with other manufacturers.

TANDEM CONFIGURATIONS

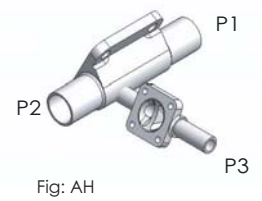
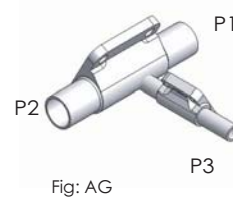
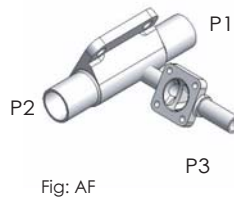
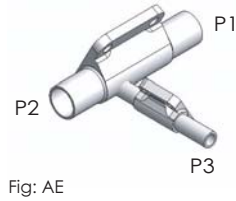
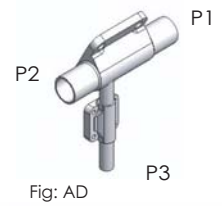
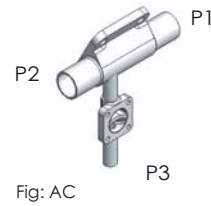
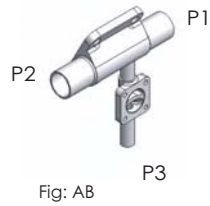
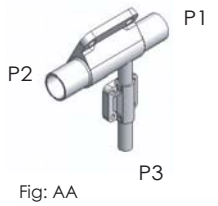
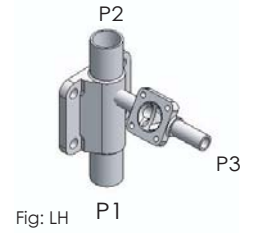
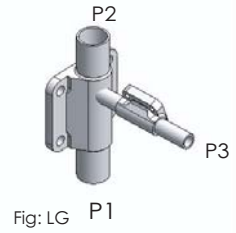
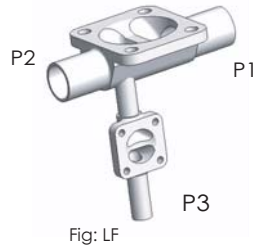
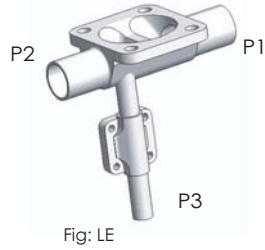
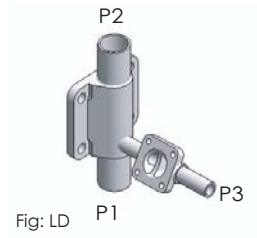
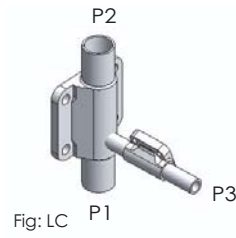
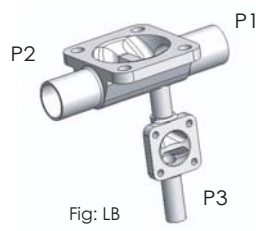
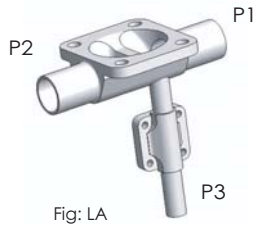

Cv VALUES

SIZE	Cv	Press Max PSI	
		TFM	EPDM
COMPACT	1.16	150	150
1/2	5.2	150	150
3/4	8.7	150	150
1	13.9	108	150
1 1/2	34.8	87	94
2	59.7	102	116
3	185	140	140
4	272	58	116

Cv values USGPM of water at 1 PSI ΔP

DRAIN ANGLE

TYPE	SIZE	DRAIN ANGLE
COMPACT	1/4	36°
	3/8	30°
	1/2	25°
STANDARD	1/2	30°
	3/4	22.5°
	1	28°
	1 1/2	20°
	2	20°
	2 1/2	25°
	3	20°
	4	15°

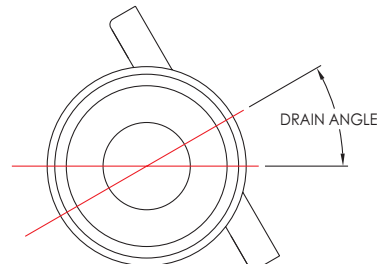

All dimensions are shown in inches.

TECHNICAL

Electro Polishing: The most effective way to improve the surface finish of a mechanically polished surface is by Electro Polishing. This electro chemical process removes the peaks of a mechanically polished surface. It also removes minor imperfections, leaving a hygienic, easy-to-clean level surface.

All MBF Standard and specialty valves offer electro polishing as an option. MBF has in-house capabilities that ensure the high quality and reliability of your diaphragm valves.

Engineered Valves: MBF's experienced engineering team uses ANSYS® software to develop special valve assemblies such as multiple diverters, sterile access and T-Block valves. MBF provides you with the optimum design data in 2D and 3D models prior to fabrication. Our engineers work closely with you to evaluate the space and operation constraints in order to design the most suitable configuration.

Registration: MBF Sanitary diaphragm valves are compliant with CSA B51 and are registered with Canadian Regulatory Authorities (CRN available on request).

docu-LINK™: For MBF customers, this unique system allows 24 hour access to our website to retrieve all related documents including Material Test Report, certificate of compliance and custom drawings. Inspired by customer feedback regarding industry availability of such documents, the **docu-LINK™** number is now tagged on each product to help you with validation!



ORDERING INFORMATION						
TYPE	SIZE	CONNECTION	FINISH	ACTUATION	DIAPHRAGM	EXTRAS
T1 - Standard Forged	S1 - 1/4" compact	C1 - OD Tube	F1 - SFV1 20Ra	A1 - Manual	D1 - EPDM	E1 - Switch 2 POS
T2 - Compact Forged	S2 - 3/8" compact	C2 - Clamp	F2 - SFV4 15Ra EP	A2 - Manual Vented	D2 - TFM/EPDM	E2 - Positioner 4..20
T3 - Divert	S3 - 1/2" compact	C3 - Custom	F3 - SFV5 20Ra EP	A3 - Spring to Close	D3 - VITON	E3 - PID
T4 - Zero Static Tee	S4 - 1/2"		F4 - Custom	A4 - Spring to Open	D4 - CUSTOM	E4 - Fieldbus
T5 - Point of Use	S5 - 3/4"			A5 - Double Acting		E5 - Custom
T6 - Tank Bottom	S6 - 1"			A6 - ECLIPSE™		
T7* Tandem	S7 - 1.5"					
T8* Ported	S8 - 2"					
T9 - Multi-Port Block	S9 - 2.5"					
	S10 - 3"					
	S11 - 4"					



*SPECIFY CONFIGURATION (SEE PAGE 8)	
LA	AA
LB	AB
LC	AC
LD	AD
LE	AE
LF	AF
LG	AG
LH	AH

EXAMPLE		
TYPE	ORDER #	DESCRIPTION
Standard Forged	T1S4C1F1A1D1	1/2" Tube 20Ra Manual EPDM
Divert	T3S4C1F1A3D2	1/2" Tube 20Ra N/C TFM/EPDM
Zero Static Tee	T4S6S4C2F1A1D1	1"(RUN) x 1/2"(DROP), Clamp, 20Ra, Manual, EPDM
Tank Bottom	T6S8C1F1A3D2	2" Tube 20Ra N/F TFM/EPDM
Tandem	T7AAS6S4C2C1F1A3A1D1	AA 1"x 1/2", Clamp x Tube, 20Ra, N/F x Manual, EPDM

NOTE: FOR DIFFERENT PORT OPTIONS SPECIFY P1/P2 (RUN) FIRST, P3 (DROP) SECOND



*MBF Stainless Valves Limited
2490 Boulevard des Entreprises
Terrebonne, QC Canada J6X 4J8*

*Tel: 450-477-2069
Fax: 450-477-6426*

*service@mbfvalves.com
www.mbfvalves.com*

MBF COMMITMENT TO QUALITY AND SERVICE.

For over 20 years, MBF products have been manufactured and serviced by dedicated people who strive to provide quality and value to every customer, every time. The Company continues to invest in technology and product development to meet the needs of the Bio Pharmaceutical Industry.

LIMITED WARRANTY

MBF Stainless Valves Limited products are warranted to be free of defects in material or workmanship for a period of one year from the date of shipment. This warranty covers those MBF products that are used in an approved installation and maintained in accordance with recognized standard practice of the industry. If, after properly authorized return, MBF determines that the products are deficient, MBF, at its option, may repair or replace such products.

MBF shall not be liable for consequential, indirect or incidental damages. The above warranty is in lieu of all other warranties, expressed or implied.

